

Pytes

PORTABLE POWER STATION

USER MANUAL

■ SAFETY INSTRUCTIONS

IMPORTANT SAFETY INFORMATION

Please read and understand all safety instructions carefully to ensure safe operation and application of the power station. Severe injury or property damage may be caused by failure to follow instructions.

The loss caused by misuse of POWER STATION is not covered by our Warranty

CHARGE NOW

Please FULLY charge the POWER STATION as soon as possible once you receive it.

The battery may be in sleep mode or lose power during long periods of transport and storage.

Plug the POWER STATION into the wall outlet for 10 minutes to reactivate the battery. If the battery still not charged after 10 minutes, please contact customer service team.

Note:

When turning on the AC Button, the LCD Display may show Output Power watts being drawn before you plug the load into the AC outlet. This is normal reaction caused by the "no-load" discharge. It is recommended that you turn off the output button(s) when not in use.

■ FEATURE DETAILS

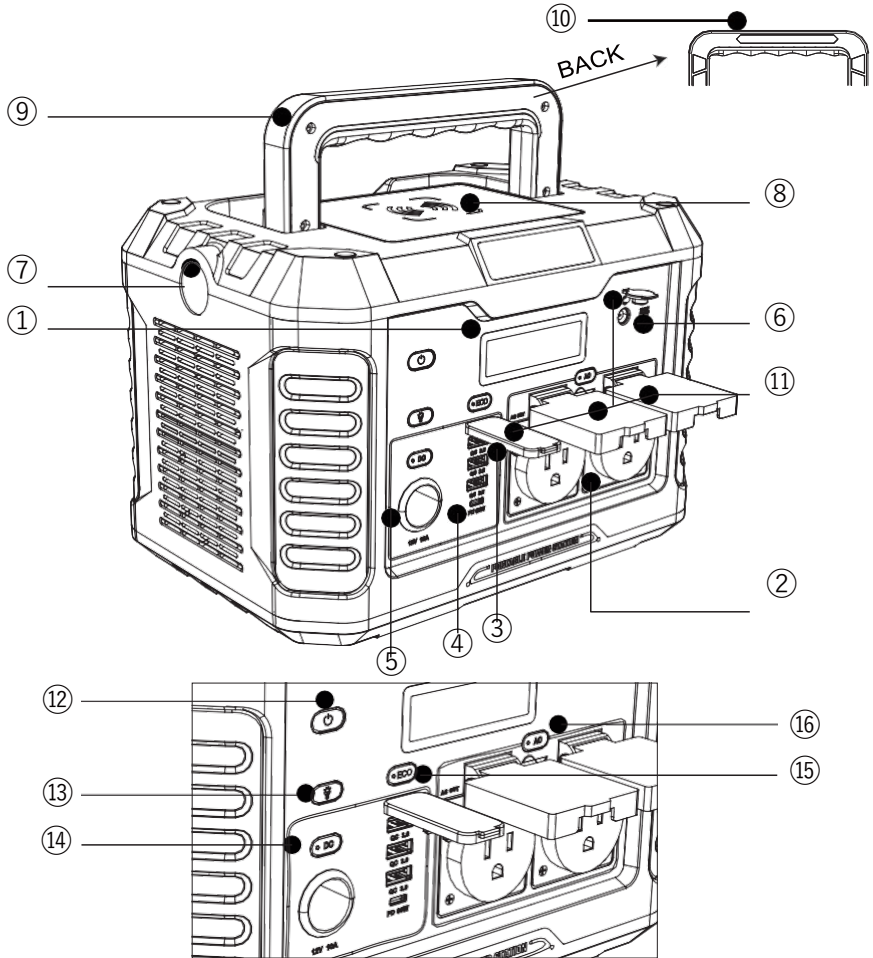

- | | | |
|--|---------------------------------|-------------------------|
| 1. LCD Display | 2. AC Outlets | 3. USB QC3.0 |
| 4. USB-TYPE-C 60W | 5. Cigarette Lighter Output | 6. DC Input |
| 7. Flashlight | 8. Wireless Charger | 9. Handle |
| 10. LED Light | 11. Protective Cover | 12. Power ON/OFF Button |
| 13. LED Light & Flashlight ON/OFF Button | 14. DC/USB Output ON/OFF Button | |
| 15. ECO Mode ON/OFF Button | 16. AC Output ON/OFF Button | |

■ OPERATION GUIDE

FUNCTION BUTTONS



Power ON/OFF Button



LED Lighting & Flashlight ON/OFF Button



DC/USB Output ON/OFF Button



ECO Mode ON/OFF Button



AC Output ON/OFF Button

12: POWER ON/OFF

POWER ON/OFF BUTTON is the Master Switch. Press POWER ON/OFF BUTTON to activate the DC/AC/ECO BUTTONS.

13: LED LIGHT & FLASHLIGHT

Press LED LIGHT & FLASHLIGHT BUTTON once to turn on the flashlight, press it again to turn on the LED LIGHT.

Press and hold the FLASHLIGHT BUTTON over 3 seconds to switch to the SOS mode.

14: DC/USB Outputs ON/OFF Button

Press DC Output ON/OFF BUTTON to activate DC/USB Output ports.

15: ECO Mode ON/OFF Button

ECO Mode: If the output ports are not in use, the power station will automatically shut down after 1 hour for energy saving.

Press the POWER ON/OFF Button, ECO Mode will be activated by default. If you do not need this function, please press the ECO ON/OFF Button to turn it off. Press ECO Button to activate the ECO Mode.

16: AC OUTLET POWER ON/OFF

Press AC Output ON/OFF BUTTON to activate AC Output Ports.

WIRELESS CHARGER

Press Power ON/OFF Button before charging. Press the Power ON/OFF Button to turn off the output.

■ OPERATION GUIDE

LCD FEATURES

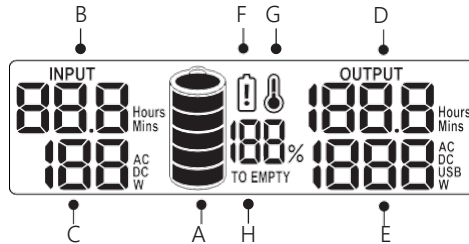

- | | | |
|--------------------------------|-----------------------------------|-------------------------------|
| A: Battery Level | B: Remaining Charging Time | C: Input Power |
| D: Remaining Usage Time | E: Output Power | F: Low Voltage Warning |
| G: Temperature Warning | H: Low Battery Alarm | |

DETAILS DISPLAYED ON LCD

Battery Level: The percentage figures and the number of battery bars represent remaining capacity.

PLEASE BE AWARE that this value varies as the energy consumption of the load changes.

Charge the POWER STATION when the battery level is below 20%. Please note that when you first charge the POWER STATION, either a solar panel or an AC Charger, it may take a few minutes to detect and adjust its charging circuit before it begins to draw power.

Remaining Charging Time: Real-time display of remaining charging time in hours and minutes.

Input Power: Real-time display of Input Power in Watts.

Remaining Usage Time: Real-time display of remaining service time in hours and minutes.

Output Power: Real-time display of the total Output Power in Watts (Cigarette Lighter Port, USB-A, USB-C and AC).

Low Voltage Warning: Please recharge the power station when the low voltage warning sign lights up.

Temperature Warning: The Temperature Warning sign will light up when the battery temperature of POWER STATION is too low/high. All functions will return to normal when the battery temperature revert to the working range.

Low Battery Alarm: The "TO EMPTY" sign will light up when the battery level is below 20%. Please charge it as soon as possible to extend battery lifespan.

■ GENERAL SPECIFICATIONS

Model	ECOX 6
Battery	Lithium Battery
Capacity	520Wh (22.2V, 23.4Ah)
Dimensions	L11.4*W7.9*H7.9 in
Weight	14.3 lbs (6.49kg)
Charging Temperature	32 to 104°F (0 to 40°C)
Discharging Temperature	14 to 104°F (-10 to 40°C)
DC Input	12-28V, 100W Max
AC Outlet	2x 600W, 1200W surge
Cigarette Lighter Port	1x 12V/10A
USB-A Ports	3x 5V/9V/12V, up to 3A, total 54W Max
USB-C Port	1x 5V/9V/12V/15V/20V, 3A, 60W Max
Wireless Charger	1x 10W
LED Lighting	1x 1W
Flashlight (SOS Mode)	1x 1W

ACCESSORIES

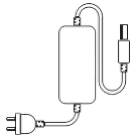

• AC Adapter

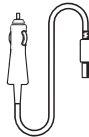

• Car Charger

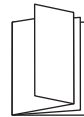

• User Manual













NOTICE:

- Check the input charge cable. The charging process can work efficiently only the input charge cable meets the specification outlined in the GENERAL SPECIFICATIONS section.
- Charge POWER STATION with provided AC adapter only.

■ GENERAL SPECIFICATIONS

NOTICE:

Available in multiple AC outlet types.

Country		Voltage/Frequency	Country		Voltage/Frequency
Universal			Israel	220V, 50Hz	
China	220V, 50Hz		Australia	240V, 50Hz	
Japan	100V, 50Hz/60Hz		UK	230V, 50Hz	
Philippines	220V, 60Hz		Germany	230V, 50Hz	
Korea	220V, 50Hz		France	230V, 50Hz	
US	120V, 60Hz		South Africa	220V, 50Hz	

■ OPERATION GUIDE

HOW TO CHARGE

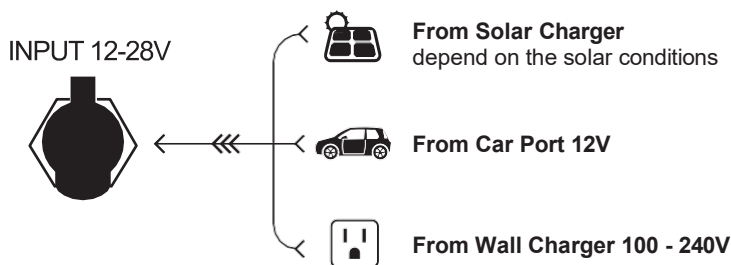

RECOMMEND TO UNPLUG THE POWER STATION WHEN IT'S FULLY CHARGED.

POWERING / CHARGING DEVICES

Select the required output port by pressing the corresponding switch button (DC (DC/USB output), AC or ECO). The output port will be activated when the indicator on the button lights up green. The LCD will display output details. Press the **POWER ON/OFF BUTTON(S)** to turn off the output(s) power when not in use.

PASS-THROUGH CHARGING

The advanced battery management system of the POWER STATION allows powering a device via DC & USB & AC output port(s) while it's charging itself.

OVERLOAD CONDITION

If the overload condition occurs to the **OUTPUT**, **POWER STATION** will automatically shut down the outlet's power.

- The LCD still display values.
- The DC Output will still be the same status as normal.

OPERATING INSTRUCTIONS

CHARGING POWER STATION

The LCD shows the battery level while charging. POWER STATION is fully charged when the figure turns to 100%. It is recommended to FULLY charge POWER STATION every 3 months to extend the battery lifespan. .

■ OPERATION GUIDE

APPLIANCE WATTS REFERENCE



Laptops
(41.4Wh)



32" TV
(60W)



CPAP without heated
humidifier (15W)



Mini Fridge
(40W)



DJ Drone
(89.2Wh)



Smartphone
(10Wh)



Air Blower
(600W)



Floodlight
(4W)



Switch
(16Wh)



Please power/charge the appliances within the rated power of power station.

The Watts/Watt Hours listed above are for reference only and not suitable for all cases.

Please check your appliance use manual for the actual power Watts.

■ MAINTENANCE

MAINTENANCE

Recharge as you need. There are no pre-designated intervals at which to recharge as long as the POWER STATION is used regularly. Avoid fully depleting the battery to 0%, it will impact the quality and lifespan of the battery. Periodically inspect all ports and wall chargers for any debris, dirt, damage, and corrosion.

DO NOT attempt to fix it on your own.

DO NOT cover the POWER STATION with towels, clothing, or other items. Periodically check the side vents to make sure there is no dirt or dust. If there is debris, follow the cleaning procedures in the manual to clean the POWER STATION.

CLEANING

Make sure any input power and output devices are **NOT** plugged into the POWER STATION. Wipe it with a clean, dry, soft, lint-free cloth. Remove any debris, dirt, or other blockages from the side vents and prevent them from falling into the interior of the Power Station.

DO NOT use abrasive cleaners or corrosive solvents.

DO NOT use compressed air to clean side vents.

DO NOT use metal objects to clean the ports to avoid the risk of electric shock.

STORAGE

Please fully charge the POWER STATION if the storage time is more than one month.

Recharge the POWER STATION every 3 months to avoid possible damages from a full discharge. Please store in a cool, moderately humid room out of direct sunlight (Refer to GENERAL SPECIFICATIONS section). Leaving POWER STATION in a car or other confined space with extremely hot temperatures will overheat the battery, resulting in a shortened lifespan and even fires.

Extremely cold temperatures will affect the performance and lifespan of the POWER STATION.

Keep away from corrosive chemicals and gases. After taking the POWER STATION out of storage, check and make sure all the accessories are in good condition. Review the air intake and side vents to ensure they are clear of debris.

Ensure safe environmental conditions are met before the POWER STATION recharge or charging other appliances.

DISPOSAL/RECYCLE

Please fully discharge the battery before disposing it. Due to the presence of hazardous chemicals, please dispose of batteries only in designated recycling channels, not with regular trash. Consult your local laws regarding battery recycling and disposal.

If the battery cannot be fully discharged due to product failure, please contact a professional battery recycling company for further processing.

Please dispose of batteries that no longer recharge.

■ TROUBLESHOOTING

Indicator	Phenomenon	Solutions
E1	AC Output Overload Warning	Please charge/power the devices within the rated power. Otherwise, the AC ON/OFF button will automatically turn off.
E2	AC Output Off	Please charge/power the devices within the rated power. And then push the AC button to restart.
E3	DC Output Overvoltage / Undervoltage	Please charge/power the devices within the rated Voltage of DC and then press the ON/OFF Button to resume the functions.
E7	DC Output Overload Protection	Please charge/power the devices within the rated power of DC and then press the ON/OFF Button to resume the functions.
E8	USB Output Overload Protection	Please charge/power the devices within the rated power of USB and then press the ON/OFF Button to resume the functions.
E4/E5/E6/E9	Output Overload Protection	When E1/E7/E8 occurs, E4/E5/E6/E9 will be displayed to more accurately identify the problem. . Please charge/power the devices within the rated powers and then press the corresponding button to restart.
E62	Over-long Charging Reminder	Stop charging after 100%.
E72	Charging Safety Protection	Unplug the charging cable and turn off the device, plug in again after a while

NOTICE:

If none of these solutions work, or if you see a warning code different from the one listed above, please stop using the power station, record the warning code, and contact customer service for further instructions.

■ TROUBLESHOOTING

Problem	Solutions	Remark
Unable to Charge	Check if the AC adapter plug is fully plugged into the DC Input and Wall Outlet.	Confirm whether it is a connecting issue.
	Check if the adapter indicator is on if connected well.	If the light is still off, please contact customer service for help.
	The charging indicator is on, but it still can't charge.	Contact customer service for help.
No Output	Ensure that the DC/USB/AC outlets are activated by pressing the corresponding button.	Once the corresponding button (s) is turned on, the output Watts will show on the LCD screen.
	Check the connected cables are appropriately plugged into the devices and power station.	Confirm the connection condition.
	Check the battery level.	Low battery will affect the outputs.
	Verify the watt data displayed on the LCD screen for an overload condition.	Overload will shut down the outputs (For more information, please see the error codes section).
Sudden interruption while using output(s)	The power used by the connected device(s) exceeds the rated power of the POWER STATION. Check if the connected device (s) is suitable for the power station by reviewing the output specifications in the GENERAL SPECIFICATIONS section.	Only plug in devices within the rated Watts. If you need a POWER STATION with a larger capacity(wh), you can browse our website or contact customer service to see which one is suitable for you.
	Check if the output power is too low. If it is too low for a few hours, the power station will automatically shut down. Please press the ON/OFF button to restart the product.	Automatic shutdown for saving energy. If you do not want the Energy-saving function, press the ECO button to turn it off.
	Check if it shuts down automatically in case of self-protection-overcurrent, over/under temperature, overload, etc. If so, simply press the power on/off button and restart the power station to restore normalcy.	Several protections to ensure the safe use of power station.

If you encounter any other problems not listed above, please contact customer service for help.

■ WARNINGS









The warnings in this manual cannot cover all possible conditions or situations that may occur.

Please use the POWER STATION with common sense and caution. Always be aware of the environment around you while using it and ensure safe and responsible use of POWER STATION.

- **DO NOT** use the POWER STATION over its output rated power. Although we have built-in overload protection, overloading may result in the risk of fire or personal injury.
- **DO NOT** use the POWER STATION or AC adapter if it is damaged or modified. Damaged or modified batteries may behave unpredictably, resulting in the risk of fire, explosion or injury.
- **DO NOT** subject to vibration, impacts, or drops. Secure the POWER STATION during transportation. While the housing may not show signs of damage, the internal components may have been damaged. It is recommended to replace it if any such severe event occurs.
- **DO NOT** expose the POWER STATION to moisture, rain, or snow.
- **DO NOT** charge, use or store the POWER STATION in the bathroom or the area exposed to water, rain, or moisture.
- **DO NOT** leave children, people with physical/mental handicap(s), or people who lack of experience and knowledge, along with the POWER STATION unless under the supervision or guidance of their guardians.
- **DO NOT** attempt to repair the POWER STATION or AC adapter. There is no user- repairable component inside.
- **DO NOT** operate the POWER STATION with wet hands.
- **DO NOT** place the POWER STATION on its side or place upside down during use or storage. If rust, odor, overheating, or other abnormal circumstances are observed, stop using it and contact customer service.
- Children should be supervised to ensure that they DO NOT play with the POWER STATION alone.
- POWER STATION is only used as emergency backup power. It cannot always replace the standard AC or DC power supply for household appliances. Keep away from high voltage electric fields.
- Do not open, crush, incinerate or heat it above 104°F (40°C). There is a risk of fire and burns. The use of a power supply, charger, or cable not recommended or sold by portable battery manufacturers may risk fire or personal injury.
- If the liquid inside the POWER STATION come in contact with your skin or clothing, wash the affected areas with water.
- The accessories included in the box should only be used with the POWER STATION.
- KEEP POWER STATION AWAY FROM PETS.

■ CAUTIONS

Transportation: POWER STATION meets all legal requirements for the transport of dangerous goods. Lithium battery pack with a capacity of more than 100Wh must be shipped in IATA standard packaging if POWER STATION is transported by air, according to international standards. IATA instructions and labeling requirements and related declarations must be completed.

 Not allowed to carry on the aircraft.	 Avoid dropping.
 To maintain the battery lifespans, please use and fully recharge at least once every three months.	 Do not disassemble.
 Use original or certified charger and cables.	 Non-waterproof, DO NOT expose to liquids.
 Avoid extreme temperature.	 Please dispose of batteries and electronic items according to local regulations.

WARRANTY

PYTES (USA) Energy, INC provides a limited warranty for the original consumer's purchase, which covers the products due to defective workmanship and materials for 12 months from the date of purchase. In order to clarify the start date of the warranty period, the sales receipt from the consumer's first purchase, or other reasonable documentary evidences are required. Our warranty does not apply to (i) Any product that has been misused, abused, modified, accidentally damaged, or used for any purpose not authorized in the company's current product datasheet, or (ii) Any product purchased through an online auction house. Please contact our customer service team for more information and to obtain warranty service.

STATEMENT

All rights reserved. All trademarks cited herein are the property of their respective owners. The information contained herein is subject to change without notice. The only warranties for the products and services are outlined in the warranty statements accompanying. We shall not be liable for technical or editorial errors or omissions contained herein.

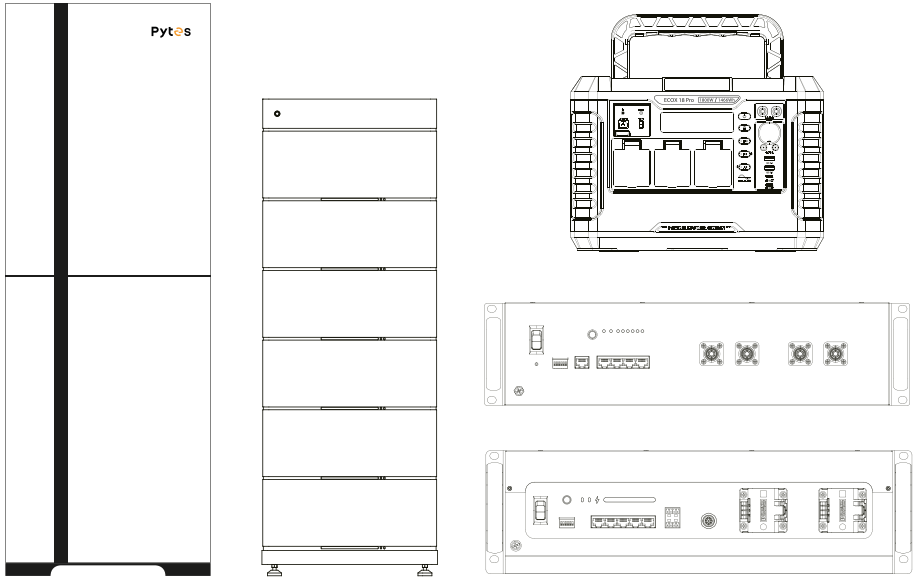

 920 S Holgate St STE 107, Seattle, WA 98134

 pytesusa@pytesgroup.com

 (+206) 407 4974

 www.pytesusa.com

Scan to follow us

