



**Building an  
excellent platform of**

# **Caring Bearing Sharing**

**2022**



Power a Better Life!



About Us ..... 01

Laboratory Introduction ..... 05

Qualification & Certification ..... 07

**Standard Products Introduction**

Batteries ..... 09

Cabinets ..... 11

All-in-One ESS ..... 18

Brackets ..... 21

HUB ..... 25

Accessories ..... 26

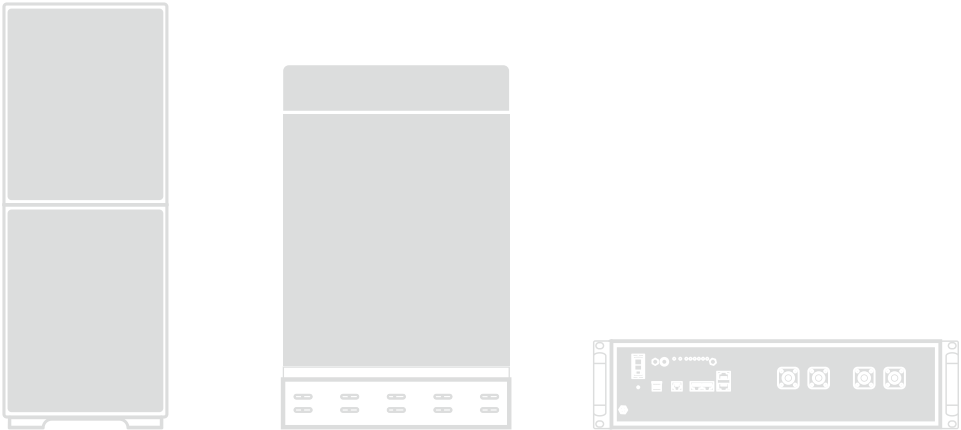

# Pytes

PYTES, a national high-tech enterprise founded in 2004, focuses on Lithium-ion battery solutions for e-bikes, 3C products, vacuum cleaners and energy storage systems, etc. Headquartered in Shanghai, PYTES has been expanding globally, setting up three production bases in Shanghai (China), Shandong (China) ,and Vietnam, two marketing & service centers in Europe and North America. PYTES is strong in R&D, with advanced laboratories certified by TUV, DEKRA, SGS & BV, etc.



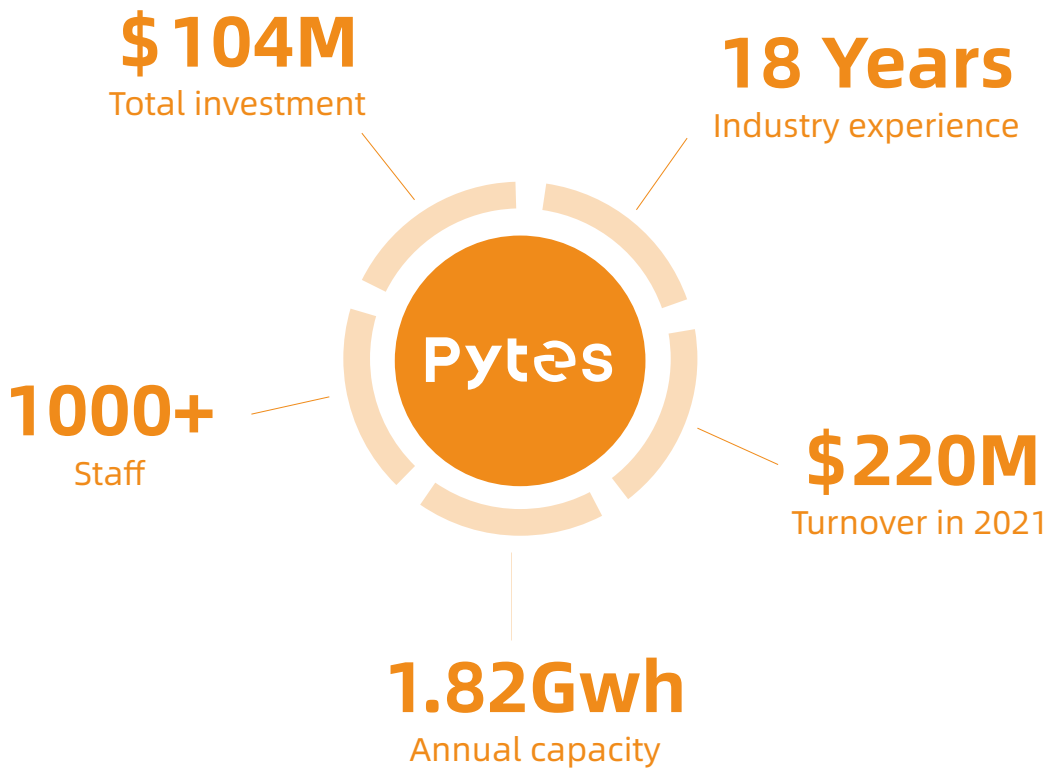

# Global Presence



PYTES EU office  
(The Netherlands)

**Europe**  
Marketing center



Factory in Shandong



**North America**  
Marketing center



PYTES USA office (USA)

**Vietnam**



Factory in Ho Chi Minh City

**China**



Headquarter in Shanghai

- Global pre-sales & after-sales services
- 7\*24H support, Efficient feedback



## Testing Labs



SGS



BV



TUV



DEKRA

## Mechanical Tests



Vibration Test



Drop Test



Shocking Test



### Safety Tests



Short circuit Test



Impact Test

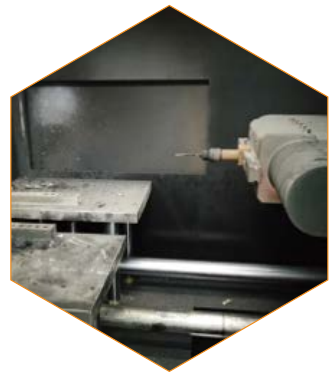

Needle Test

### Environmental Tests



Altitude Simulation



Thermal Shock

### Electrical Tests





## Qualification & Certification



ISO9001:2015



ISO14001:2015



UL2271



IEC62619



UL1973



RoHS



CB



UL



PSE



KC



REACH



UN38.3



GB31241



CU



IEC62133



## Standard Products Introduction

# E-BOX-48100R



## Introduction

E-BOX series, the new generation LFP battery for home energy storage system. It provides safe, well-designed and high-performance standard LFP battery pack. The battery pack is compact, easy to install, free of maintenance and can be installed in parallel in the energy storage system to increase its capacity. It is widely applied in residential applications, small commercial and industrial energy storage system as well as Telecom stations.

## Features



### Self-Consumption

store excess energy generated by solar panels and use it whenever needed



### Back-Up Power Supply

provide emergency power supply during grid outage



### Electricity Bills Reduction

charge the battery during off-peak period and discharge the battery during peak period



### Smart Energy Management

measure, monitor and manage the system in real-time  
optimize the system life span by intelligent algorithms



### Longest Life and Highest Safety

more than 6000 cycles @90%DOD



### Wide Compatibility

compatible with mainstream inverters

**10 Years Warranty**



**UN38.3**



# Batteries

05-024321-11



## E-BOX-48100R

L440mm\* W620mm \* H117mm (2.6U)  
L17.32" \* W24.41" \* H4.61" (2.6U)  
51.2V100Ah 5.12kWh

## Operation Panel

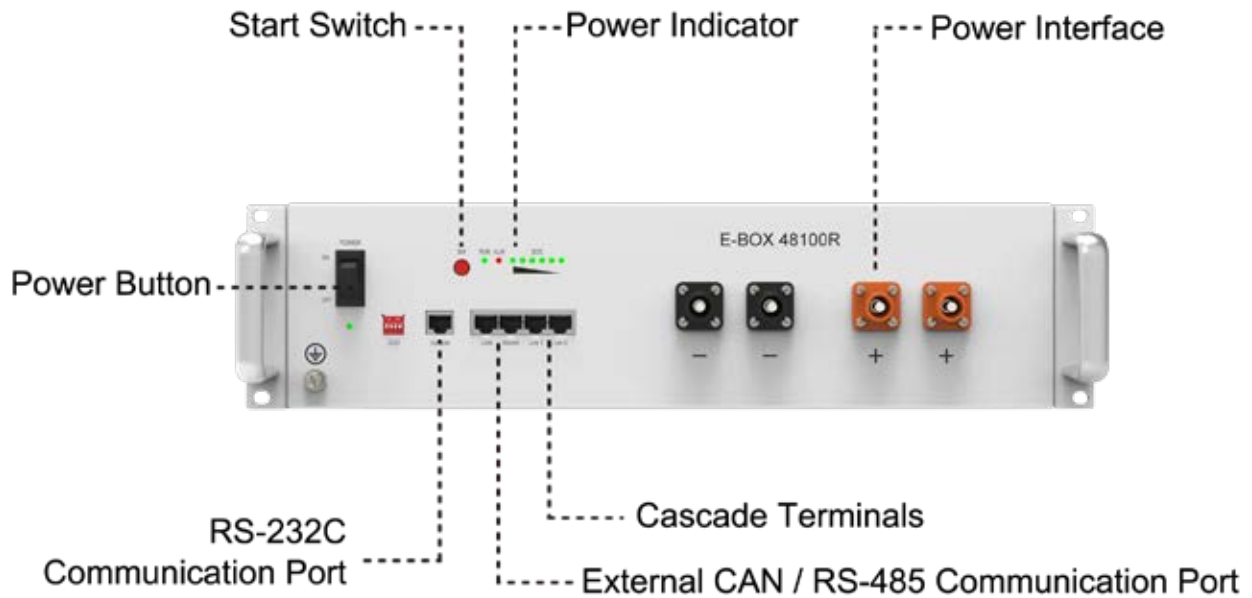

## Technical Specifications

Battery Model	E-BOX-48100R
Chemistry	LFP
Nominal Voltage	51.2V
Voltage Range	47.5V-58V
Nominal Capacity	100Ah
Nominal Energy	5.12kWh
Unit Dimension (L*W*H)	17.32 * 6.54 * 3.50 inch (440 * 420 * 89 mm)
Unit Weight	112.5lbs
Peak Discharge Rate	102A (5.22kW@15s)
Maximum Continuous Discharge Rate	50A (2.56kW DC)
Standard Continuous Discharge Rate	50A (2.56kW DC)
Maximum Continuous Charge Current	50A
Standard Continuous Charging Current	50A
Round-Trip Efficiency	≥95%
Communication Protocol	RS232, RS485, CAN
Cycle Life	≥6000cycle
Calendar Life	≥10years
Operating Temperature	14°F~122°F
Connect style	Parallel
Storage Temperature	<1month: -4~131°F, 1-3months: 32~95°F, 3-12months: 68~77°F

## Brackets For E-Box-48100R (2.6U)



14-171385-31: Front Bracket

14-171384-31: Rear Bracket





# R-BOX

## Introduction

The R-BOX is a state-of-the-art home energy storage system solution. It has a total usable energy capacity of 10kWh. Product features include quick and easy installation, a compact and elegant home style design and great extensibility. The R-BOX can provide smart configurable backup power during grid outages and power smart homes with solar energy, day and night.

## Technical Specifications

Model	R-BOX
Total capacity	10.24kWh
Usable capacity	9.22kWh
Chemistry	Lithium iron phosphate (LFP)
Nominal voltage	51.2V
Max. charge/ discharge current	100A
Communication	CAN, RS485
Certificate	UL1973, CE, UN38.3
Operating Temperature	Charge:32~113°F, Discharge:14~122°F
Altitude	< 6562ft (2000m)

Mechanical Design	Parameter
Dimensions (L*W*H)	11.0 * 20.1 * 27.5 inch (30.8 inch H w/ holder) 280 * 510 * 700 mm (780 mm H w/ holder)
Weight	264lbs
Mount	Wall / Floor mount
Enclosure rating	IP20
Enclosure material	Cool-rolled steel
Cooling	Natural convection
Warranty	6000 cycles or 10 years

## Designed for two E-BOX-48100R battery models

### 3D image



### Mechanical Drawing

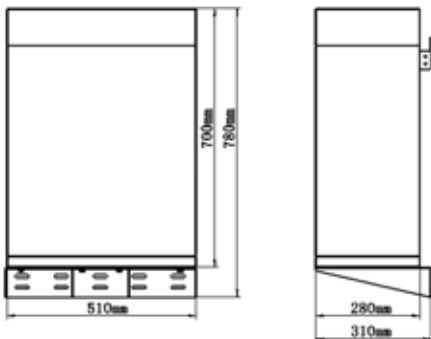

### Battery Expansion

Pytes Home Energy Storage System can connect R-BOX up to 3 pcs without additional kit.



# R-BOX-A



## Mechanical Drawing

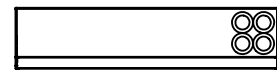
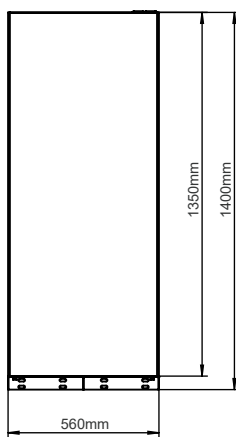





## Introduction

The PYTES R-BOX-IP65 is a state-of-the-art home energy storage system solution. It has a total usable energy capacity of 10kWh. Product features include quick and easy installation, a compact and elegant home style design and great extensibility. The PYTES R-BOX-IP65 can provide smart configurable backup power during grid outages and power smart homes with solar energy, day and night.

## Technical Specifications

Model	IP65
Total capacity	10.24kWh
Usable capacity	9.22kWh
Chemistry	Lithium iron phosphate (LFP)
Nominal voltage	51.2V
Max. charge/ discharge current	100A
Communication	CAN, RS485
Certificate	UL1973, CE, UN38.3
Operating Temperature	Charge:32~113°F, Discharge:14~122°F
Altitude	< 6562ft (2000m)

Mechanical Design	Parameter
Dimensions (L*W*H)	12.2 * 20.9 * 29 inch (33.7 inch H w/ holder) 400 * 530 * 736 mm (856 mm H w/ holder)
Weight	264lbs
Mount	Wall / Floor mount
Enclosure rating	R-BOX-IP65
Enclosure material	Cool-rolled steel
Cooling	Natural convection
Warranty	6000 cycles or 10 years

### 3D image



### Mechanical drawing

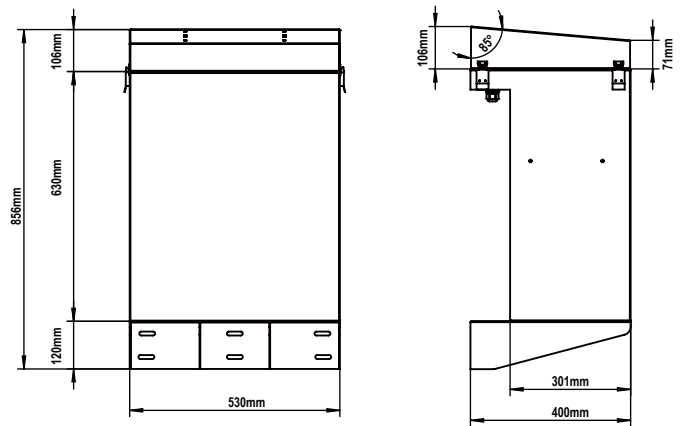

### Battery Expansion

PYTES Home Energy Storage System can connect R-BOX-IP65 up to 3 pcs without additional kit.

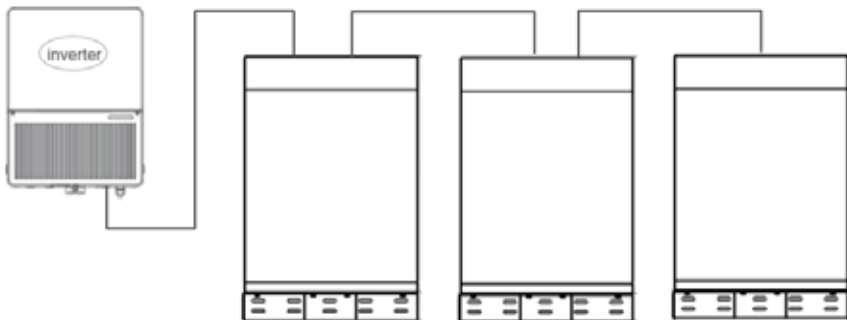

## Energy Storage Battery



# Forest RB

- Easy to install
- Expandable up to 6 units E-BOX-48100R(30kWh in total)
- Long usage life
- Adapt to multiple Inverters

## Application Scenario



Villa



Communication  
base station



Households



Farm

## Introduction

Expand your energy storage with the Forest RB Cabinet! This iron enclosure stores up to 6 E-BOX-48100R batteries. The Forest RB Cabinet paired with multiple batteries can build a 48V UPS server rack or provide storage capacity to home solar arrays.

## Product Topology

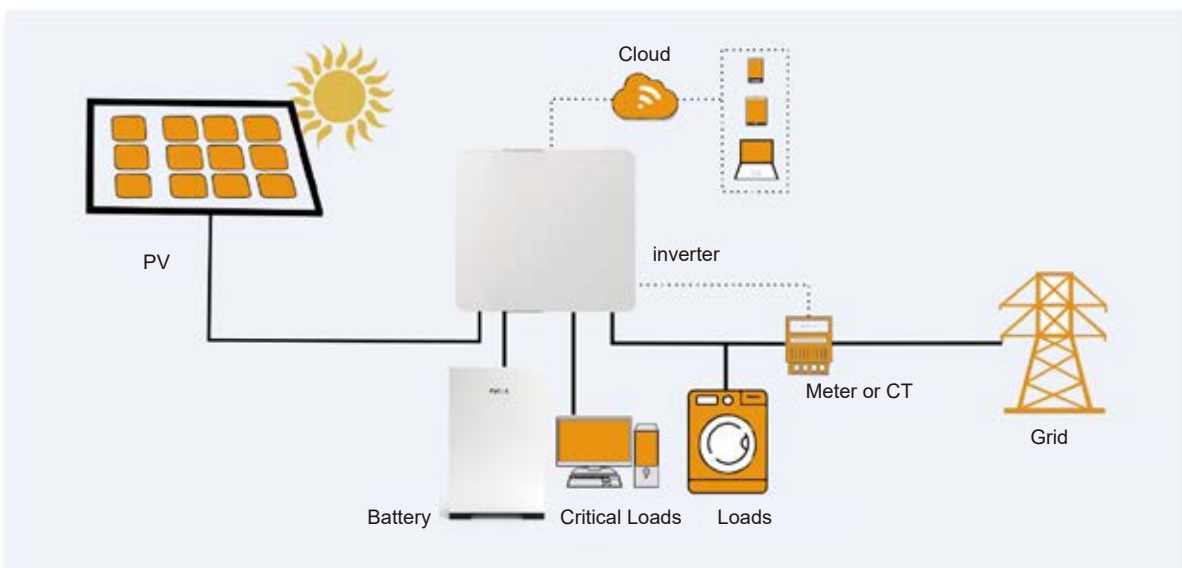

## Product Topology

	B2	B3	B4	B5	B6
Battery capacity	10.24kWh	15.36kWh	20.48kWh	25.6kWh	30.72kWh
Nominal voltage	51.2V				
Standard Charge/Discharge Current	100A	150A	200A	250A	300A
Maximum Charge/Discharge Current	100A	150A	200A	250A	300A
Operating Temperature	Charge:32~113°F, Discharge:14~122°F				
Warranty	Cabinet: 3 years Battery: 10 years				
Positive and Negative Battery Busbars	2*8 points;M8 terminal rings				
Weight	264lbs	374lbs	485lbs	595lbs	705lbs
Dimensions (L*W*H)	28.3 * 15.7 * 45.3 inch (720 * 400 * 1150mm)				
Enclosure Protection	IP20 (indoor)				
Alltitude	< 6562ft (2000m)				
Certificate	UL1973, CE, UN38.3				

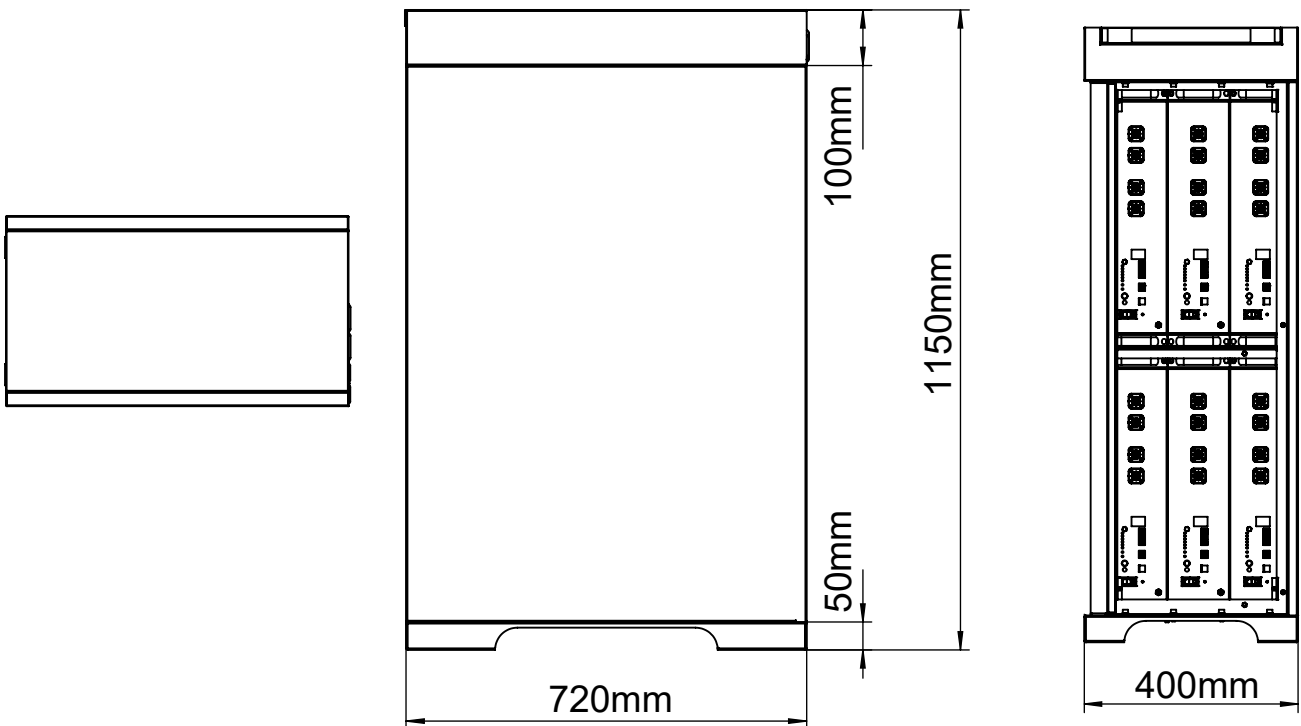

**Pytes**

**Forest R**



## Introduction

The Forest R, a new generation of energy storage products that integrate inverters and batteries, and is a landmark "New Home appliance". Forest R can manage your energy usage throughout the day, provide smart configurable backup power during grid outages and power smart homes with solar energy, day and night.

## Specification

### General Specification

Capacity	5.12kWh per battery module, up to 6 modules
Transfer switch	Automatic, integrated
Listed and recognized certificates	Battery modules: UL1973, CE, UN38.3 Inverter : UL1741 SB, CA Rule 21, HECO Rule14H
Warranty	Battery: 10 years or 6,000 cycles Inverter: 10 years Cabinet: 10 years
Temperature range	Charge:32~113°F, Discharge:14~122°F

### Battery Module Specification

DC battery input voltage	47.5–57.6V
Max. charge rate	0.5C
Cell discharge	5.12kWh with 90% DoD
Overcharge Protection	MOSFET & Fuse protection

# Technical Specification

	R2	R3	R4	R5	R6
Capacity	10.24kWh	15.36kWh	20.48kWh	25.6kWh	30.72kWh
Nominal voltage	51.2V				
Amps hours	200Ah	300Ah	400Ah	500Ah	600Ah
Weight (approximate)	330lbs	440lbs	551lbs	661lbs	771lbs
Dimensions (L*W*H)	28.34 * 17.71 * 74.80 inch (720 * 450 * 1900 mm)				

Inverter	Sol-Ark-5K-P	Sol-Ark-8K-48-ST	Sol-Ark-12K-P	Sol-Ark-15K-LV
Solar output power	5000W	9000W	12000W	15000W
Max DC voltage	500V@18A, 450V@20A	500V@18A, 450V@20A	500V@18A, 450V@20A	500V@26A
MPPT voltage range	150~425V	150~425V	150~425V	150~425V
Start-up voltage	125V	125V	125V	125V
No. of MPPT trackers	2	2	2	3
Max DC current per MPPT (self limiting)	10A	20A	20A	26A
Rated AC output power	5000W 20.8A-L (240V)	8000W 33.3A L-L (240V)	9000W 37.5A L-L (240V)	12000W 50A-L(240V)
Parallel stacking	Not supported	Not supported	Yes	Yes
Grid type	120/240/208V split phase	120/240/208V split phase	120/240/208V split phase	120/240/208V split phase

## Designed for one hybrid inverter + 2~6 pcs batteries

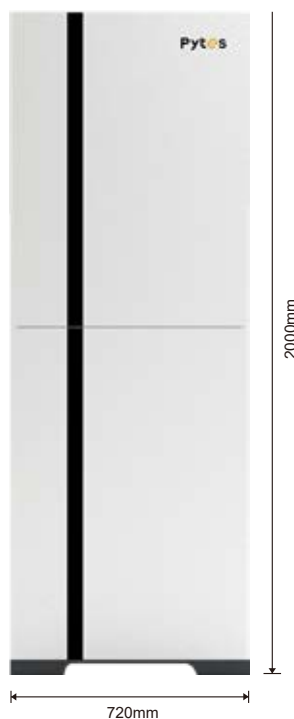

# Pytes

## Pros

### AC Coupling to Existing Inverters

- 12kW DC Coupling
- 20kW Peak Power
- 6000 Cycle Battery
- 4ms Transfer Time
- Generator Support
- Parallel Stacking
- 10yr Warranty
- Battery Agnostic
- Battery Losses 7%
- Excellent Technical Support

## System



Lithium Iron Phosphate Battery Module  
E-BOX-48100R (5kWh)



Sol-Ark Hybrid  
Inverter Series



Stacked up to 8pcs with  
R-Brackets (40kWh in total)



Or Forest R Cabinet



Sol-Ark hybrid inverter



2~6 pcs E-BOX-48100R  
(From 10kWh to 30kWh)

## R Bracket



### Introduction

In order to install the E-BOX-48100R Battery more conveniently and reduce installation costs, PYTES has developed this battery bracket. You can use it on a single battery or on multiple battery packs. Compared with cabinet storage, besides taking up less space, the bracket can ventilate and reduce the heat much more easily.





## Parameters

Unit Dimension (L*W*H)	20.9 * 28.5 * 5.3 inch (535 * 725 * 135 mm)
Unit Weight	17lbs
Installation	<ol style="list-style-type: none"> <li>1.Install the parts by following the guide of the installation manual;</li> <li>2.Screws are needed to assemble single battery and rack;</li> <li>3.Multi-layer battery rack: after assembling all the single batteries and racks, stack them up vertically. Connection board is needed to install in between each two layers of battery racks ;</li> <li>4.Secure multi-layer battery rack with accessories to the wall;</li> <li>5.Connect multi-layer battery rack to the distribution box.</li> </ol>

## Can bear more weight



## Mechanical drawing

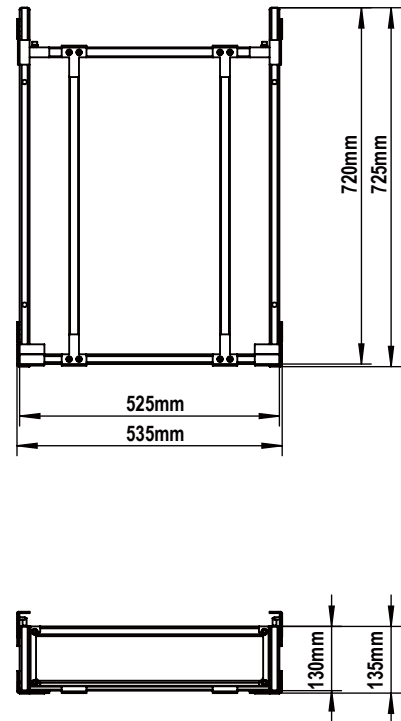



Each communication hub connects maximum 7 battery groups

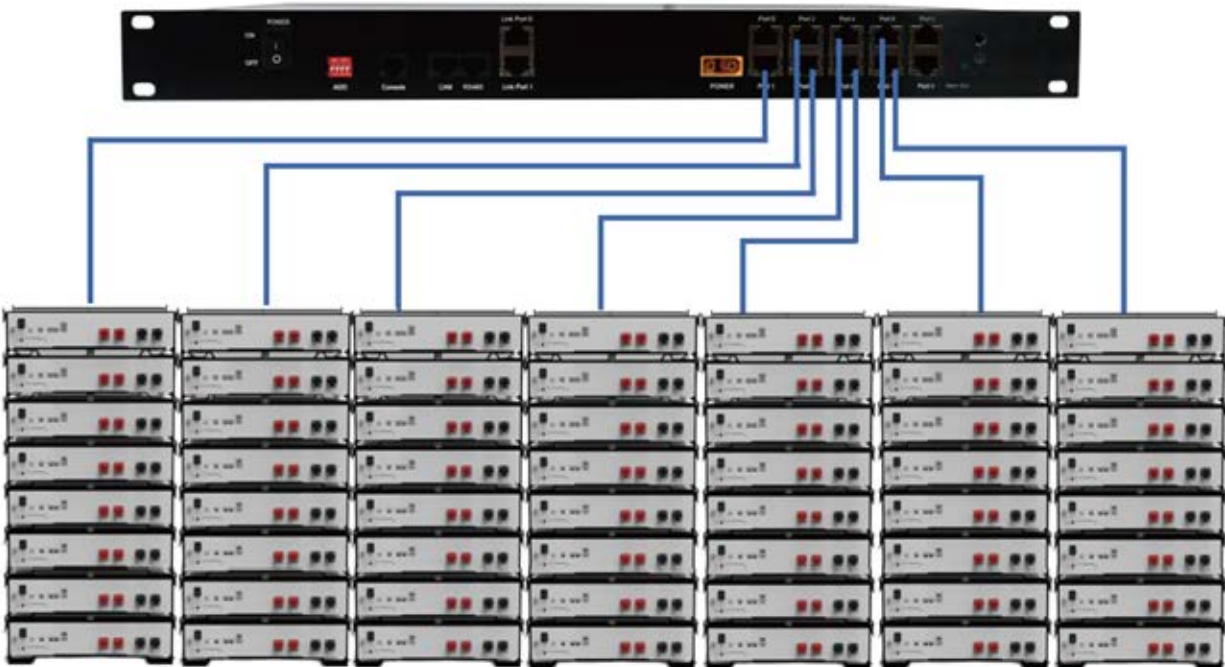

Each group supports maximum 8 pcs E-BOX-48100R in parallel

# Accessories



Battery to Battery

- 18-041343-31: 160mm Positive Power Cable (6.30")
- 18-041344-31: 160mm Negative Power Cable (6.30")
- 22-ABUJ00401: 240mm Positive Power Cable (9.45")
- 22-ABUJ00402: 240mm Negative Power Cable (9.45")
- 18-041341-31: 560mm Positive Power Cable (22.04")
- 18-041342-31: 560mm Negative Power Cable (22.04")



Battery to Inverter

- 18-041339-31: 500mm Positive Power cable (19.68")
- 18-041340-31: 500mm Negative Power cable (19.68")
- 18-041336-31: 2000mm Positive Power cable (6'6.74")
- 18-041337-31: 2000mm Negative Power cable (6'6.74")



Battery to Battery

- 18-041315-31: 220mm Standard communication cable (8.66")
- 18-041318-31: 350mm Standard communication cable (13.77")
- 22-ABUJ00366: 500mm Standard communication cable (19.68")



Battery to Inverter

- 18-061203-31: A Class 1500mm (5')
- Compatible:HUB、 solark、 solis、 goodwe、 growatt、 SMA can
- 18-061207-31: A Class 3500mm (11'5.79")
- Compatible:VoltronicOffGrid 485
- 18-061208-31: A Class 3500mm (11'5.79")
- Compatible:VoltronicOffGrid 485
- 18-061209-31: A Class 3500mm (11'5.79")
- Compatible:HUB、 solark、 solis、 goodwe、 growatt、 SMA can
- 18-021089-31: A Class 1000mm (3'3.37")
- Compatible:solark、 luxpower、 growatt 485
- 22-ABUJ00386: A Class 2000mm (6'6.74")
- Compatible:victtron can
- 18-021080-31 : B Class 500mm (1'6.68")
- Compatible:solark、 solis、 growatt 485/can SMA、 goodwe can SRNE 485
- 18-061206-31 : B Class 500mm (1'6.68")
- Compatible:solark、 solis、 growatt 485/can SMA、 goodwe can SRNE 485
- 18-041316-31: B Class 3500mm (11'5.79")
- Compatible:solark、 solis、 growatt 485&can、 SMA、 goodwe can、 SRNE 485



05-070000-11: RS 232 communication cable

---

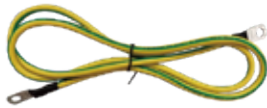

18-041317-31: 1000mm Earth Cable (3'3.37")

---



05-041382-11: Smart Meter

---



05-060000-11: 48V 300A Bus Bar

---

# SMART MONITOR

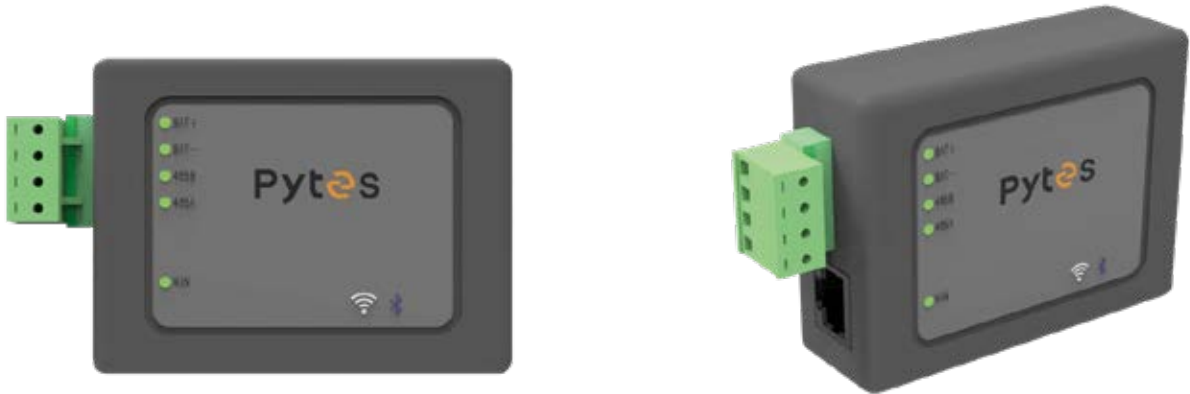

## Smart Monitor feature

1. Battery remote upgrade;
2. Battery fault monitoring;
3. Historical fault inquiry;
4. Historical power inquiry;
5. Mobile APP and cloud monitoring;
6. Wireless and Bluetooth two ways of connection ;
7. Multi-level management ;

## Diagram



## WEB/APP

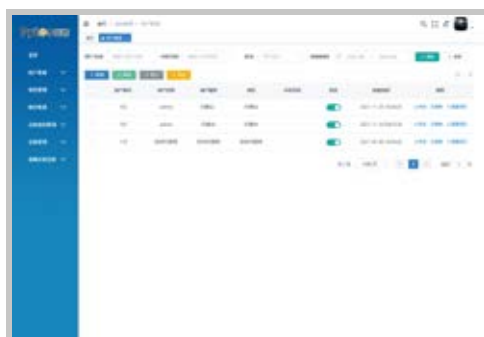

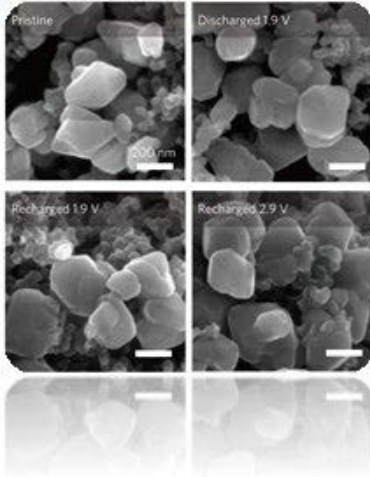

## Cells& Packs

- The olivine structure and the stability of P-O bond of LFP cells guarantee much higher safety than those of NCM cells.
- 17 years experiences of pack R&D ensure longer cycle life of the battery.

## Self-designed BMS

- Equipped with automotive grade chips
- Double protection by master chips. When the main chip fails, the back-up chip keeps protecting the system.
- Real-time temperature, current, voltage measuring and monitoring.
- Accurate SoC and SoH calculation.



## Quality Assurance

- UL1973/ IEC62619/ CE/ UN38.3 Certificates
- TÜV, SGS, BV International Certified Cooperative Testing Laboratories.

## Quick Response

Quick local after-sales response/ 24hours\*7days.



## Compatibility List of PYTES ESS and Inverters



# Pytes

## **PYTES (USA) Energy Inc.**

920 S Holgate St, STE 106, Seattle, Washington, 98134 USA

Cell (America): +1 206 482 0843

## **Shanghai PYTES Energy Co., Ltd.**

NO.3492, Jinqian Road, Fengxian District, Shanghai, China

+86-21-57475800



More Catalogs



Scan to follow us



[www.pytesgroup.com](http://www.pytesgroup.com)

**Pytes**